

# Ambir ImageScan Pro<sup>®</sup> 930u

High Speed Document Scanner with  
UltraSonic Misfeed Detection

## User Guide



[www.ambir.com](http://www.ambir.com)

## Table of Contents

---

<b>Box Contents</b>	<b>2</b>
<b>Installation and Setup</b>	<b>3,4</b>
<b>Loading Documents</b>	<b>5</b>
<b>Scanning</b>	<b>6,7,8,9</b>
<b>Calibration</b>	<b>10</b>
<b>Cleaning the ADF</b>	<b>10</b>
<b>Replacing the Pad Module</b>	<b>11</b>
<b>Clearing Paper Jams</b>	<b>11</b>
<b>Scanner Connection</b>	<b>12</b>
<b>LED Indication</b>	<b>12</b>
<b>Ultrasonic Sensor</b>	<b>12</b>

## Box Contents

---

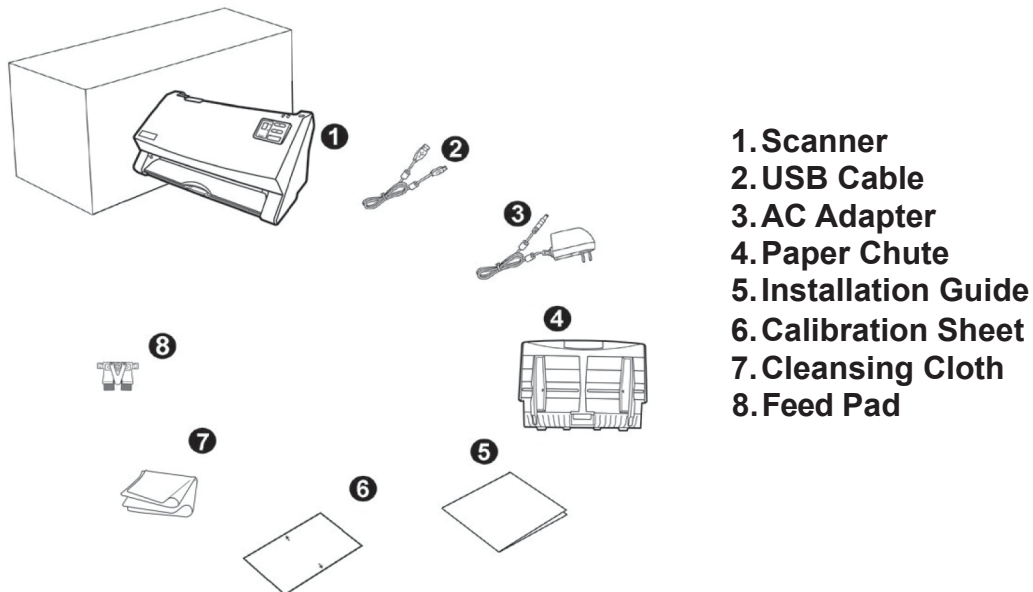



## Installation and Setup

### Step 1. Install the Paper Chute

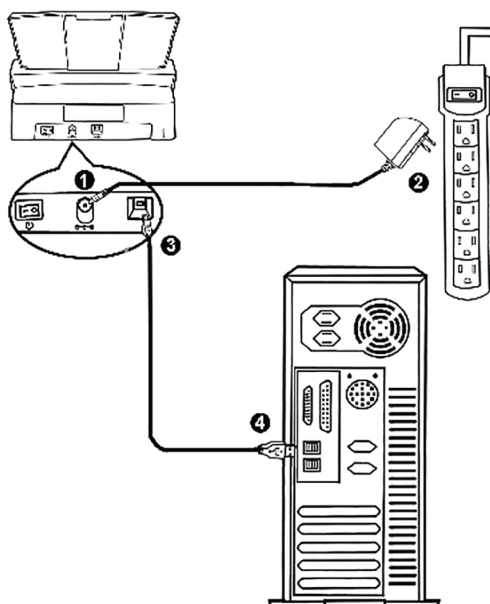
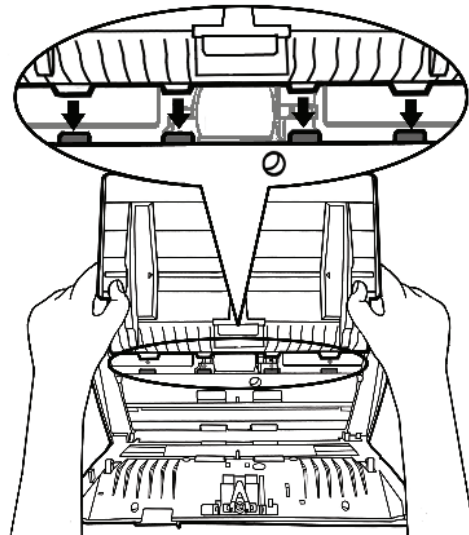
1. Open the ADF cover by pulling the lever.
2. Install the paper chute by aligning and inserting the tabs of the paper chute into their slots on the scanner.
3. Close the ADF cover by pushing it back down until it snaps back into place.



### Step 2. Connecting the Scanner to Your Computer

1. Plug the AC adapter into the scanner's power receptor .
2. Plug the other end of the AC adapter into a standard AC power outlet.
3. Plug the square end of the included USB cable to the USB port  at the rear of the scanner.
4. Plug the rectangular end of the USB cable to an available USB port on your computer.

## Installation and Setup (Continued)

---



### Step 3. Installing the Software

Visit [www.ambir.com/900u-series-set](http://www.ambir.com/900u-series-set) to download your scanner driver and AmbirScan ADF software.



## LOADING DOCUMENTS

1. Load the documents, headfirst and face down, toward the center of the ADF paper chute and all the way into the ADF until touching the bottom.

For single-sided scans, load the documents face down so that the side to be scanned faces towards the paper chute.

For double-sided scans, load the desired page order of documents face down so that the side to be scanned faces towards the paper chute.

If you wish to scan both sides of a single page, the page need only pass through the ADF once – you will need to set the scan type to “Duplex.”

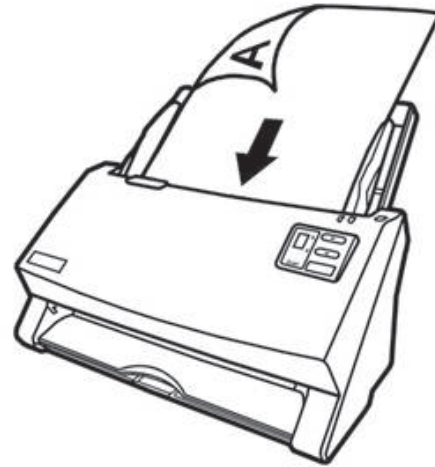

2. If you need to scan longer documents, pull out the paper chute extension and stacker to provide further support for the documents.

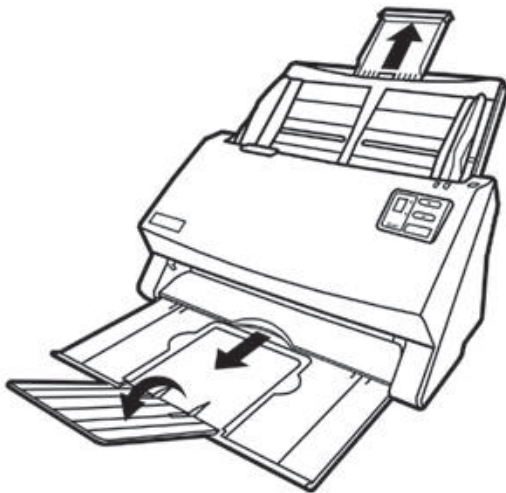

3. Adjust the paper width slider for the paper size you are using. The paper width slider should be gently touching both sides of the documents.

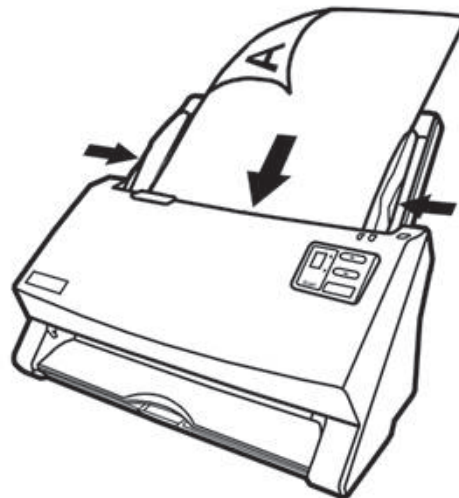

### Attention

**DO NOT** load more than 100 sheets of paper (70 g/m<sup>2</sup>, 18 lb.) to the ADF.

Paper scanned from the ADF must be a minimum of 5.08 x 5.08 cm (2" x 2", W x L).

**Make sure there are no gaps between the document stack and the paper-width slider; otherwise, the scanned images can be skewed.**

**Although the documents should be loaded firmly in place ensuring optimum scanning accuracy, they should never be wedged in so tightly that the process of feeding them through the scanner is strained.**

**Do not load additional paper into the ADF while the unit is feeding and scanning.**

## Scanning

---

### **There are three different ways to operate the scanner:**

1. By acquiring images from the scanner through our TWAIN interface within any TWAIN-compliant application programs.
2. By scanning from the buttons on the Scanner's front panel.
3. By scanning from AmbirScan ADF's Execute menu on the screen.

### **Scanning via TWAIN Interface**

#### **Select the Scan Source:**

If you have more than one scanner or other imaging devices installed on your computer, you need to set this scanner as the default scanning source before you acquire image data/scan using a TWAIN compliant program.

## Scanning (Continued)

---

### Scanning from the Scanner's Front Panel

Completing scanning projects using the scanner buttons is easy and convenient. The number assigned to a scanning task displayed on the scanner's front panel is configured through AmbirScan ADF. AmbirScan ADF offers you quick access to the most frequently-used scanning functions. They are especially useful when you need to repeatedly scan with the same settings and send images to the same destination. Before performing your first scan via scanner buttons, first configure the button settings with your preferences.

### Scan with Scanner Buttons

1. Place the document or images into the scanner.
2. Press the UP or DOWN button to select the desired task.
3. Press the Scan button.

The scanner starts to scan immediately and carry out the corresponding action according to settings in the Button Configuration window.

## Scanning (Continued)

---

### Configure Button Settings

Within the “Button Configuration” window, you can find a row of icons running through the left side of the window. Each icon represents a scanning task, and the number underneath corresponds to the function number displayed on the scanner front panel.

Nine (9) frequently-used scanning tasks are pre-configured for your convenience. You may, however, customize the settings of the nine tasks to best meet your needs and preferences.

#### Follow the steps below:

1. Do one of the following to open the Button Configuration window:

Double-click the  icon in the Windows system tray.

Right-click the  icon in the Windows system tray, and then choose **Button Configuration...** in the pop-up menu that opens.

2. Select a task number by clicking on the icon.
3. Select the desired function from the drop-down list of Button Template and adjust button settings.

Click the Help button within the Button Configuration window for more information about the button settings.





## Scanning (Continued)

---

### View Button Settings

There are two ways to view the button settings:

1. Double-click the  icon in the Windows system tray.
2. Right-click the  icon in the Windows system tray, and then choose “Button Configuration...” in the pop-up menu that opens.

### Scanning from the AmbirScan ADF On-screen Execute Menu

You may also use AmbirScan ADF’s on-screen Execute menu to perform the same scanning tasks. This program provides a quick and convenient way to perform various scanning functions.

**Follow the steps below:**

1. Place the document or images onto the scanner.
2. Right-click the  icon in the Windows system tray, and then choose **Execute** in the pop-up menu that opens.
3. Click the desired button function item in the pop-up menu. The scanner starts to scan immediately and carries out the corresponding action according to the button configuration you set.

## Calibration

Calibrate the scanner if colors appear in areas that should be white, or colors of the scanned image and the original vary a lot. This allows you to adjust and compensate for variations that can occur in the optical component over time by its nature.

The included Calibration Sheet, marked with an arrow on either edge at both sides, is used specifically for calibrating the ImageScan Pro® 930u.

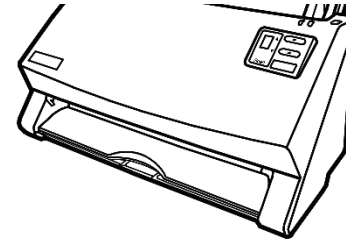

**The following describes how to calibrate the scanner:**

1. Insert the special Calibration Sheet into the ADF of the scanner, with the arrow pointed toward the scanner buttons.
2. Click Start > All Programs > Your scanner model name > Calibration Wizard.
3. Click Next from the Calibration Wizard that pops up, then click Calibrate Now....
4. Click on the Start button to begin the calibration process.
5. The scanner pulls the calibration sheet through the scanner, which completes the calibration process. After the calibration is complete, click OK and then click Finish.

## Cleaning the ADF

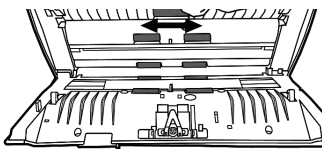

Have the following cleaning materials ready to clean the scanner:

soft, dry, lint-free cloth      non-abrasive cleaner fluid: Isopropyl rubbing alcohol(95%)

### DO NOT USE WATER

1. Open the ADF cover by pulling the lever.
2. Gently wipe the following areas with the cloth dampened with the cleaner. Be careful NOT to scratch their surfaces.

#### Clean Feed Roller:

Wipe the Feed Roller from side to side and then rotate it. Repeat this until its entire surface is cleaned.

#### Clean Pad Module:

Wipe the Pad Module from top to bottom (in the direction of arrow shown in below picture). Be careful not to damage the pick springs of the pad.

1. Wait for cleaned areas to dry completely.
2. Close the ADF cover by pushing it back down until it snaps back into place.

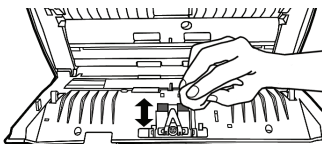

## Replacing the Pad Module

---

1. Open the ADF cover by pulling the cover open lever.
2. Remove the pad module by pinching both sides of the pad module. Pull it out.
3. Install the new pad module by inserting the tabs on the module onto their slots on the scanner.
4. Close the ADF cover by pushing it back down until it snaps back into place.

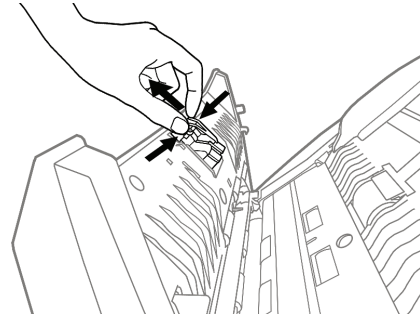

## Clearing Paper Jams

---

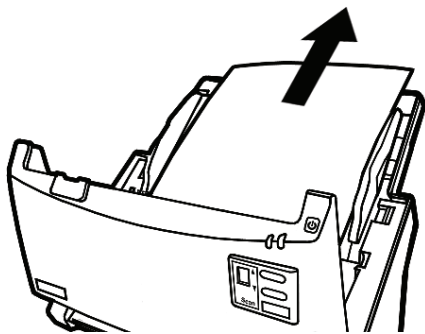



If a paper jam in the ADF happens, please perform the following steps:

1. Remove any unjammed documents still loaded into the ADF.
2. Open the ADF cover by pulling the cover open lever.
3. Gently but firmly pull the jammed documents out of the ADF. Try to avoid creasing or wrinkling the documents.
4. Close the ADF cover by pushing it back down until it snaps back into place.

## Scanner Connection

The first step to take when troubleshooting connection problems with your scanner is to check all physical connections.

The icon ,  located on the Windows system tray, indicates if the scanner software is properly launched and the scanner and computer are communicating with each other.

Appearance	Status
	The program has been successfully launched and the scanner is connected with the computer, ready to scan images.
	The scanner is not connected with the computer, or the scanner power is not switched on.
No Display	You have chosen to terminate the program. The scanner may or may not be connected to the computer.

## LED Indication

Warning LED Light	Power / Power Saving LED Light	Status
Off	White	The scanner is turned on, ready to scan images.
Off	Orange	The scanner is in standby mode (sleep mode) if it is idle for 10 minutes.
Red	Blinking White	The ADF cover is opened.
Blinking Red	White	Paper jam.
Blinking Red	Off	An internal component of the scanner may have malfunctioned.
Off	Off	The scanner is off, either because the power is not turned on, or because the AC adapter is not properly plugged into an AC power outlet.

**The Power/Power Saving LED and Warning LED indicate different scanner status.**

## Ultrasonic Sensor

When scanning a stack of documents by ADF, the ultrasonic sensor detects multifeeds by checking paper overlap (i.e., 2 or more pages stuck together when being fed through the ADF). Clean the ultrasonic sensor lightly with a dry cloth if it is necessary.

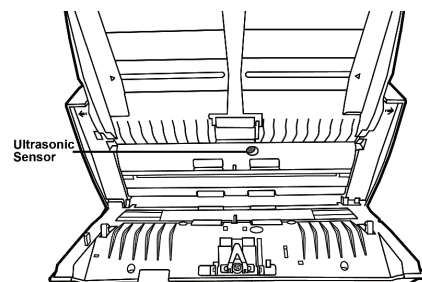



[www.ambir.com](http://www.ambir.com)